

	Descrizione	Codice
1	Albero compensatore	800309
2	Boccola scanalata	800130
3	Vite M5x30	800324
4	Molla	800318
5	Spina 2x16	800312
6	Grano M3x3	220039
7	Cilindro	800307/1

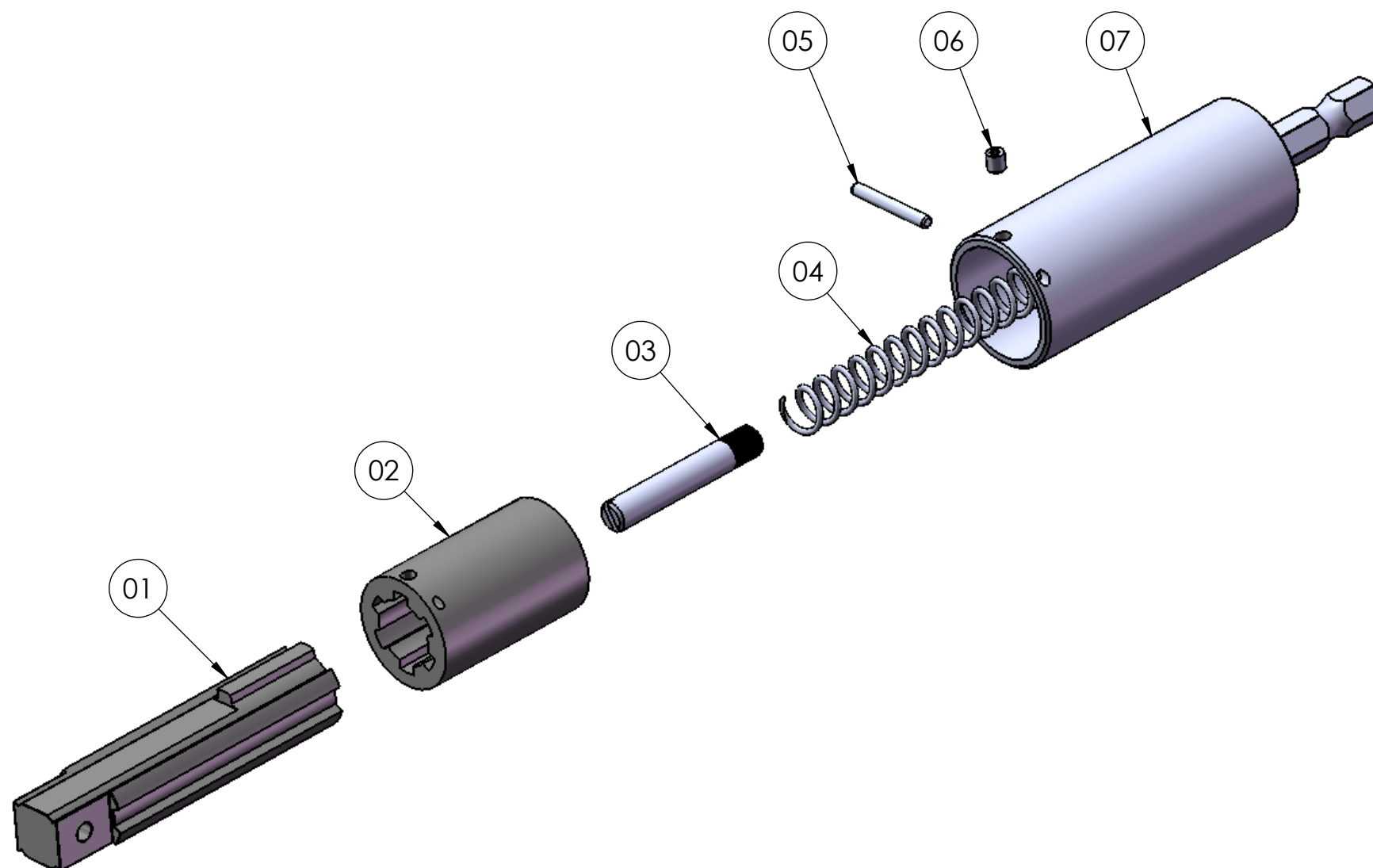

Tolleranze dove non segnate		REVISIONE	NOME	FIRMA	DATA	MATERIALE:	
Lunghezza	Fino 10mm	±0.02mm	0	Marcon Davide	12/05/2014		
	Fino 100mm	± 0.3mm					
	Fino 300mm	± 0.1mm					
	Oltre	± 1mm					
Diametro	Fori	JS11	1			Nome Compensatore 1/4"-3/8"	
	Alberi	js11	2				
<small>THE INFORMATION CONTAINED IN THIS DRAWING IS THE SOLE PROPERTY OF KOLVER S.R.L. ANY REPRODUCTION IN PART OR AS A WHOLE WITHOUT THE WRITTEN PERMISSION OF KOLVER S.R.L. IS PROHIBITED.</small>		<i>Kolver S.R.L.</i>			Codice	800320	
						FORMATO	A3